

SENTRON, Fuse switch disconnecter 3NP1, 3-pole, NH3, 630 A, for assembly and installation on mounting plate, flat terminal, cover level 70 mm

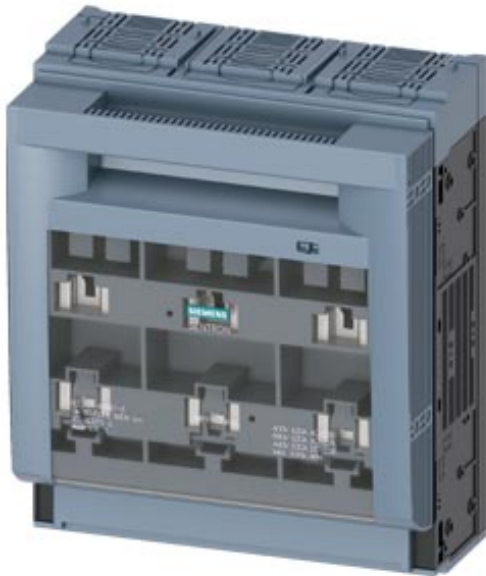

Model	
Product brand name	SENTRON
Product designation	3NP1 fuse switch disconnecter
Design of the product	cover level 70 mm
Design of the safety monitoring	Without
Design of the operating mechanism	Cover handle
Design of the load switch / Strip form	No
Type of the driving mechanism / motor drive	No

General technical data	
Number of poles	3
Type of device	For assembly and installation on mounting plate
Size of disconnecting link	3 and 2
Size of fuse link	NH2, NH3
Continuous current / at 35 °C / rated value	630 A
Let-through current / with closed switch / maximum permissible	60 kA
cut-off value $I^{**2}t_{max.}$ / 500 V	5 400 000 A ² ·s
Power factor	
• at AC-22 B	0.65

<ul style="list-style-type: none"> • at AC-23 B 	0.35
<ul style="list-style-type: none"> • with capacitive load 	-0.25
circuit-breaker / Design	3NP11
Mechanical service life (switching cycles) / typical	1 000
Fuse system	LV HRC fuse
Degree of pollution	3

Voltage

Insulation voltage	
<ul style="list-style-type: none"> • rated value 	690 V
<ul style="list-style-type: none"> • with degree of pollution 3 / rated value 	690 V
<ul style="list-style-type: none"> • with degree of pollution 2 / rated value 	1 000 V
Power factor / at AC-21 B	0.95
Surge voltage resistance / rated value	8 kV
Current / at AC / rated value	630 A
Operating voltage	
<ul style="list-style-type: none"> • at AC / rated value / maximum 	690 V
<ul style="list-style-type: none"> • at DC / rated value 	440 V
<ul style="list-style-type: none"> • at DC / rated value / maximum 	440 V

Protection class

Protection class IP	
<ul style="list-style-type: none"> • with closed switch / with cover or cable lug cover 	IP40
<ul style="list-style-type: none"> • with closed switch / without cover or cable lug cover 	IP30
<ul style="list-style-type: none"> • on the front 	IP40
<ul style="list-style-type: none"> • open 	IP20

Dissipation

Power loss [W]	
<ul style="list-style-type: none"> • with conventional rated thermal current / without fuse / per pole 	30 W
<ul style="list-style-type: none"> • with conventional rated thermal current / without fuse / per device 	90 W
<ul style="list-style-type: none"> • for rated value of the current / at AC / in hot operating state / per pole 	78 W
<ul style="list-style-type: none"> • of the fuse / per fuse / maximum 	48 W

Current

Operating current	
<ul style="list-style-type: none"> • at AC-23 B / at 690 V / rated value 	200 A
<ul style="list-style-type: none"> • at AC-23 B / at 500 V / rated value 	500 A
<ul style="list-style-type: none"> • at AC-23 B / at 400 V / rated value 	630 A
<ul style="list-style-type: none"> • at AC-23 B / at 240 V / rated value 	630 A

• at AC-22 B / at 690 V / rated value	500 A
• at AC-22 B / at 500 V / rated value	630 A
• at AC-22 B / at 400 V / rated value	630 A
• at AC-22 B / at 240 V / rated value	630 A
• at AC-21 B / at 690 V / rated value	630 A
• at AC-21 B / at 500 V / rated value	630 A
• at AC-21 B / at 400 V / rated value	630 A
• at AC-21 B / at 240 V / rated value	630 A
• at DC-23 B / at 440 V / rated value / maximum	250 A
• at DC-23 B / at 240 V / rated value / maximum	400 A
• at DC-23 B / at 120 V / rated value / maximum	400 A
• at DC-22 B / at 440 V / rated value / maximum	500 A
• at DC-22 B / at 240 V / rated value / maximum	630 A
• at DC-22 B / at 120 V / rated value / maximum	630 A
• at DC-21 B / at 440 V / rated value / maximum	630 A
• at DC-21 B / at 240 V / rated value / maximum	630 A
• at DC-21 B / at 120 V / rated value / maximum	630 A
Continuous current	
• rated value	630 A
• at 40 °C / rated value	610 A
• at 45 °C / rated value	575 A
• at 50 °C / rated value	555 A
• at 55 °C / rated value	530 A
Let-through current / with high-speed activation / maximum permissible	50 kA
Let-through current / I _c / maximum permissible	
• 400 V	60 000 A
• 500V	60 000 A
cut-off value I ² t _{max.} / 400 V	4 340 000 A ² ·s
Main circuit	
Operating current / with capacitive load	
• at 400 V / maximum	72 A
• at 500 V / maximum	55 A
Auxiliary circuit	
Number of CO contacts / for auxiliary contacts	0
Number of NC contacts / for auxiliary contacts	0
Number of NO contacts / for auxiliary contacts	0
Suitability	
Suitability for use	
• Main switch	No
• switch disconnecter	Yes

• EMERGENCY OFF switch	No
• safety switch	Yes
• maintenance/repair switch	Yes

Product details

Product feature / interlock	Yes
Product component	
• Trip indicator	No
• Phase failure monitoring	No
• undervoltage release	No
• undervoltage release with leading contact	No
Product feature / sealable	Yes
Product extension	
• Auxiliary switch	Yes
• optional	
— locking capability	Yes
— motor drive	No
— Phase failure monitoring	Yes
— fuse monitoring	Yes
— Voltage trigger	No
— Overvoltage protection monitoring	Yes

Product function

Product function	
• fuse monitoring	No
• Overvoltage protection monitoring	No

Short circuit

Conditional short-circuit current (I _q)	
• rated value	50 kA
• at AC / at 240 V / with high-speed activation / rated value	50 kA
• at AC / at 500 V / with high-speed activation / rated value	50 kA
• at AC / at 690 V / with high-speed activation / rated value	50 kA
• with closed switch / at AC / at 240 V / rated value	100 kA
• with closed switch / at AC / at 500 V / rated value	100 kA
• with closed switch / at AC / at 690 V / rated value	100 kA

Connections





Arrangement of electrical connectors / for main current circuit	other
Connectable conductor cross-section / for main contacts	
<ul style="list-style-type: none"> • single or multi-stranded • stranded 	120 ... 300 mm ² 120 ... 300 mm ²
Tightening torque / with screw-type terminals	10 ... 12 N·m
Type of connection	Flat terminal
Type of electrical connection / for main current circuit	busbar connection

Mechanical Design

Height	306 mm
Width	249.4 mm
Depth	138.5 mm
Mounting type	mounting plate
Mounting type	
<ul style="list-style-type: none"> • floor mounting • front mounting • front mounting with 4-hole attachment • front mounting with central attachment • rail mounting 	Yes No No No No
Mounting position	horizontal/vertical
Net weight	4.63 kg
<ul style="list-style-type: none"> • during operation • during storage 	-25 ... +55 °C -50 ... +80 °C

Certificates

Reference code	
<ul style="list-style-type: none"> • acc. to DIN EN 61346-2 • acc. to DIN EN 81346-2 	Q Q

General Product Approval	Declaration of Conformity	Test Certificates
 CCC	 UR	 VDE
	Miscellaneous	 EG-Konf.
		Special Test Certificate

Test Certificates	Shipping Approval
-------------------	-------------------

[Type Test Certificates/Test Report](#)



LRS

Further information

Information- and Downloadcenter (Catalogs, Brochures,...)

<http://www.siemens.com/lowvoltage/catalogs>

Industry Mall (Online ordering system)

<https://mall.industry.siemens.com/mall/en/en/Catalog/product?mfb=3NP1163-1DA10>

Service&Support (Manuals, Certificates, Characteristics, FAQs,...)

<https://support.industry.siemens.com/cs/ww/en/ps/3NP1163-1DA10>

Image database (product images, 2D dimension drawings, 3D models, device circuit diagrams, ...)

http://www.automation.siemens.com/bilddb/cax_en.aspx?mfb=3NP1163-1DA10

CAX-Online-Generator

<http://www.siemens.com/cax>

Tender specifications

<http://www.siemens.com/specifications>

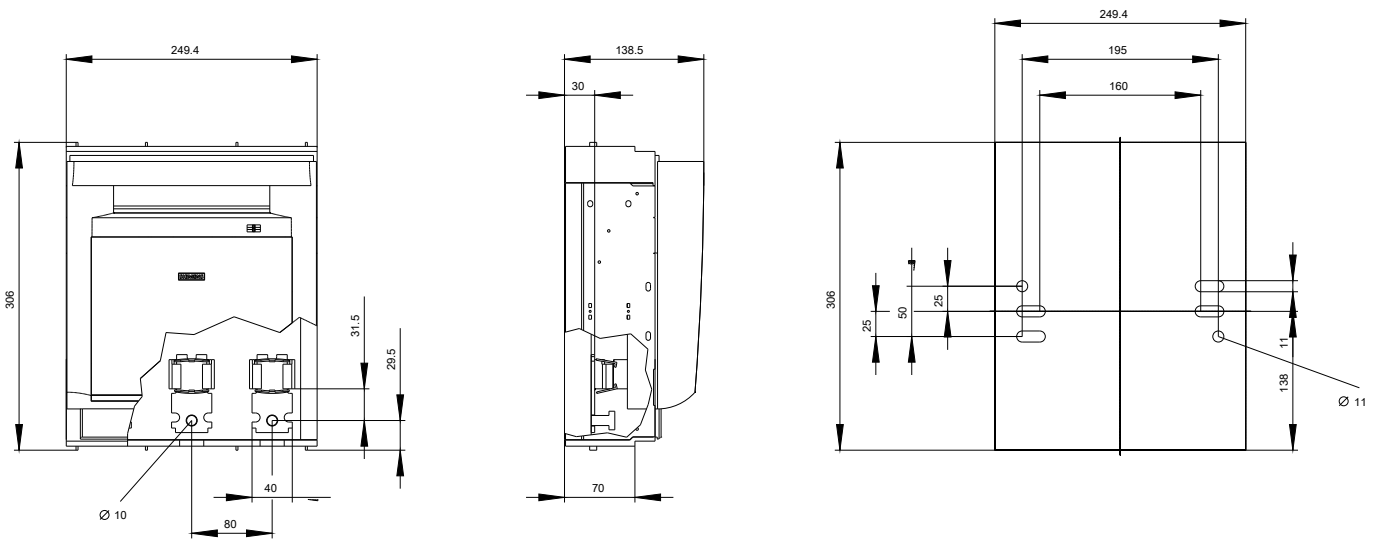

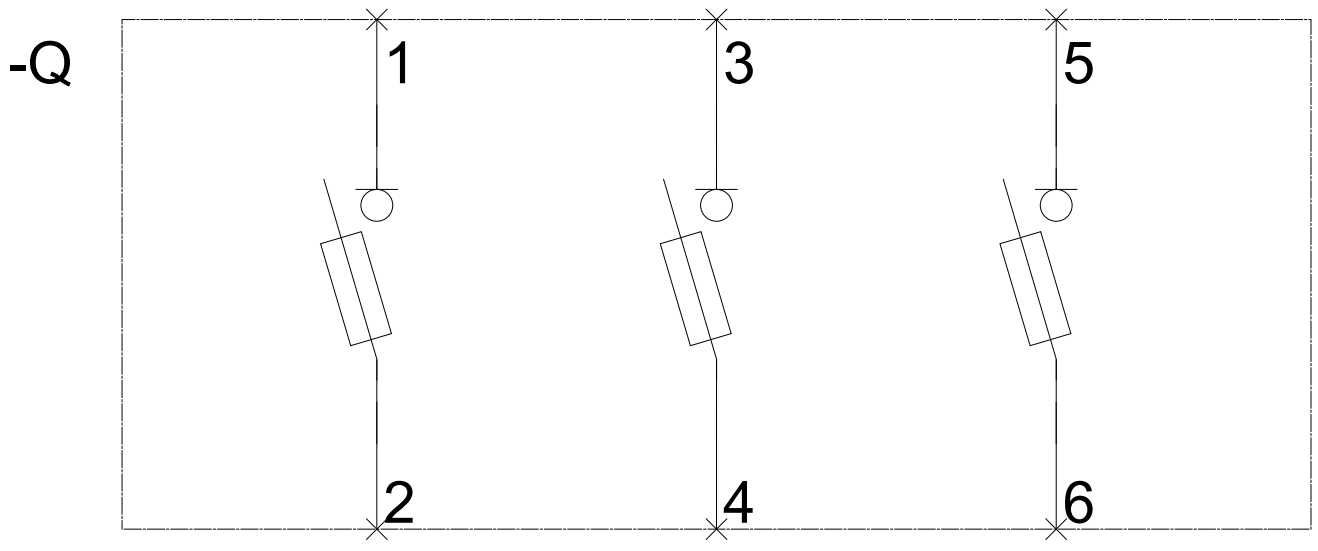

-CB

