

Capacitor contactor, AC-6b 25 kVA_r, / 400 V 1 NO + 2 NC, 230 V AC, 50 Hz 3-pole, Size S0 screw terminal



Product brand name	SIRIUS
Product designation	capacitor contactors
Product type designation	3RT26
General technical data	
Size of contactor	S0
Product extension	
• Auxiliary switch	No
Surge voltage resistance	
• of main circuit rated value	6 kV
• of auxiliary circuit rated value	6 kV
maximum permissible voltage for safe isolation	
• between coil and main contacts acc. to EN 60947-1	400 V
Protection class IP	
• on the front	IP20
• of the terminal	IP20
Shock resistance at rectangular impulse	
• at AC	8,3g / 5 ms, 5,3g / 10 ms
Shock resistance with sine pulse	

<ul style="list-style-type: none"> • at AC 	13,5g / 5 ms, 8,3g / 10 ms
Mechanical service life (switching cycles)	
<ul style="list-style-type: none"> • of the contactor with added auxiliary switch block typical 	3 000 000
Electrical endurance (switching cycles)	200 000
Reference code acc. to DIN EN 81346-2	Q

Ambient conditions	
Installation altitude at height above sea level	
<ul style="list-style-type: none"> • maximum 	2 000 m
Ambient temperature	
<ul style="list-style-type: none"> • during operation 	-25 ... +60 °C
<ul style="list-style-type: none"> • during storage 	-55 ... +80 °C

Main circuit	
Number of NO contacts for main contacts	3
Number of NC contacts for main contacts	0
Operating current	
<ul style="list-style-type: none"> • at AC-6b at 690 V at ambient temperature 60 °C rated value 	36 A
Operational reactive power at AC-6b	
<ul style="list-style-type: none"> • at 230 V at 50/60 Hz at ambient temperature 60 °C rated value 	5 ... 14 kvar
<ul style="list-style-type: none"> • at 400 V at 50/60 Hz at ambient temperature 60 °C rated value 	8 ... 25 kvar
<ul style="list-style-type: none"> • at 500 V at 50/60 Hz at ambient temperature 60 °C rated value 	10 ... 31 kvar
<ul style="list-style-type: none"> • at 690 V at 50/60 Hz at ambient temperature 60 °C rated value 	14 ... 43 kvar
No-load switching frequency	
<ul style="list-style-type: none"> • at AC 	500 1/h
Operating frequency at AC-6b	
<ul style="list-style-type: none"> • at 230 V maximum 	100 1/h
<ul style="list-style-type: none"> • at 240 V maximum 	100 1/h
<ul style="list-style-type: none"> • at 400 V maximum 	100 1/h
<ul style="list-style-type: none"> • at 480 V maximum 	100 1/h
<ul style="list-style-type: none"> • at 500 V maximum 	100 1/h
<ul style="list-style-type: none"> • at 600 V maximum 	100 1/h
<ul style="list-style-type: none"> • at 690 V maximum 	72 1/h

Control circuit/ Control	
Type of voltage	AC
Type of voltage of the control supply voltage	AC
Control supply voltage at AC	
<ul style="list-style-type: none"> • at 50 Hz rated value 	230 V

Control supply voltage frequency • 1 rated value	50 Hz
Operating range factor control supply voltage rated value of magnet coil at AC • at 50 Hz	0.8 ... 1.1
Apparent pick-up power of magnet coil at AC	77 V·A
Inductive power factor with closing power of the coil	0.82
Apparent holding power of magnet coil at AC	9.8 V·A
Inductive power factor with the holding power of the coil	0.25
Closing delay • at AC	8 ... 40 ms
Arcing time	10 ... 15 ms
Residual current of the electronics for control with signal <0> • at AC at 230 V maximum permissible	7 mA

Auxiliary circuit

Number of NC contacts for auxiliary contacts • attachable • instantaneous contact	2 0 2
Number of NO contacts for auxiliary contacts • attachable • instantaneous contact	1 0 1
Operating current of auxiliary contacts at AC-12 maximum	10 A
Operating current of auxiliary contacts at AC-15 • at 230 V • at 400 V	6 A 3 A
Operating current of auxiliary contacts at DC-13 • at 24 V • at 60 V • at 110 V • at 125 V • at 220 V	6 A 2 A 1 A 0.9 A 0.3 A
Contact reliability of auxiliary contacts	0.00000001

UL/CSA ratings

Contact rating of auxiliary contacts according to UL	A600 / Q600
---	-------------

Short-circuit protection

Design of the fuse link • for short-circuit protection of the main circuit — with type of coordination 1 required	gG: 80 A (690 V, 50 kA)
--	-------------------------

- for short-circuit protection of the auxiliary switch required

gG: 10 A (500 V, 1 kA)

Installation/ mounting/ dimensions

Mounting position	+/-180° rotation possible on vertical mounting surface; can be tilted forward and backward by +/- 22.5° on vertical mounting surface
Mounting type	screw and snap-on mounting onto 35 mm standard mounting rail according to DIN EN 50022
Height	135 mm
Width	45 mm
Depth	155 mm
Required spacing	
<ul style="list-style-type: none"> • with side-by-side mounting <ul style="list-style-type: none"> — at the side 	10 mm
<ul style="list-style-type: none"> • for grounded parts <ul style="list-style-type: none"> — at the side 	10 mm

Connections/ Terminals

Type of electrical connection	
<ul style="list-style-type: none"> • for main current circuit 	screw-type terminals
<ul style="list-style-type: none"> • for auxiliary and control current circuit 	screw-type terminals
Type of connectable conductor cross-sections	
<ul style="list-style-type: none"> • for main contacts <ul style="list-style-type: none"> — solid — stranded — single or multi-stranded — finely stranded with core end processing • at AWG conductors for main contacts 	2x (1 ... 2.5 mm ²), 2x (2.5 ... 10 mm ²) 2x (1 ... 2.5 mm ²), 2x (2.5 ... 10 mm ²) 2x (1 ... 2,5 mm ²), 2x (2,5 ... 10 mm ²) 2x (1 ... 2.5 mm ²), 2x (2.5 ... 6 mm ²), 1x 10 mm ² 2x (16 ... 12), 2x (14 ... 8)
Type of connectable conductor cross-sections	
<ul style="list-style-type: none"> • for auxiliary contacts <ul style="list-style-type: none"> — solid — single or multi-stranded — finely stranded with core end processing • at AWG conductors for auxiliary contacts 	2x (0.5 ... 1.5 mm ²), 2x (0.75 ... 2.5 mm ²), 2x 4 mm ² 2x (0,5 ... 1,5 mm ²), 2x (0,75 ... 2,5 mm ²), 2x 4 mm ² 2x (0.5 ... 1.5 mm ²), 2x (0.75 ... 2.5 mm ²) 2x (20 ... 16), 2x (18 ... 14), 2x 12
Type of minimum connectable cross-section for main contacts at AC-6b	
<ul style="list-style-type: none"> • at 40 °C • at 60 °C 	1x 10 mm ² 2x 10 mm ²
AWG number as coded connectable conductor cross section for main contacts	16 ... 8

Safety related data

Product function	
<ul style="list-style-type: none"> • Mirror contact acc. to IEC 60947-4-1 	No









- positively driven operation acc. to IEC 60947-5-1

No

Protection against electrical shock

finger-safe

Certificates/ approvals

General Product Approval			EMC	Declaration of Conformity	
 CCC	 CSA	 UL	 EAC	 RCM	 EG-Konf.
Declaration of Conformity	Test Certificates	Marine / Shipping	other		
Miscellaneous	Type Test Certificates/Test Report	 BUREAU VERITAS	 RMRS	Confirmation	 VDE

Further information

Information- and Downloadcenter (Catalogs, Brochures,...)

www.siemens.com/sirius/catalogs

Industry Mall (Online ordering system)

<https://mall.industry.siemens.com/mall/en/en/Catalog/product?mlfb=3RT2627-1AP05>

Cax online generator

<http://support.automation.siemens.com/WW/CAXorder/default.aspx?lang=en&mlfb=3RT2627-1AP05>

Service&Support (Manuals, Certificates, Characteristics, FAQs,...)

<https://support.industry.siemens.com/cs/ww/en/ps/3RT2627-1AP05>

Image database (product images, 2D dimension drawings, 3D models, device circuit diagrams, EPLAN macros, ...)

http://www.automation.siemens.com/bilddb/cax_de.aspx?mlfb=3RT2627-1AP05&lang=en

Characteristic: Tripping characteristics, I²t, Let-through current

<https://support.industry.siemens.com/cs/ww/en/ps/3RT2627-1AP05/char>

Further characteristics (e.g. electrical endurance, switching frequency)

<http://www.automation.siemens.com/bilddb/index.aspx?view=Search&mlfb=3RT2627-1AP05&objecttype=14&gridview=view1>

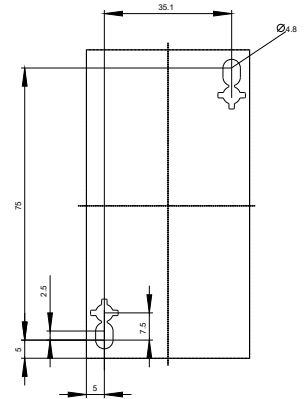
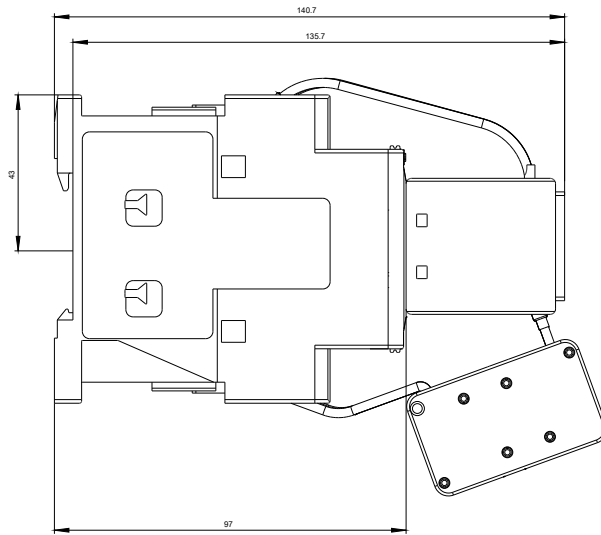
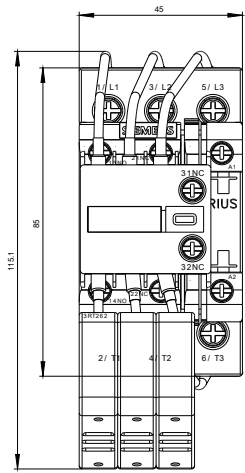

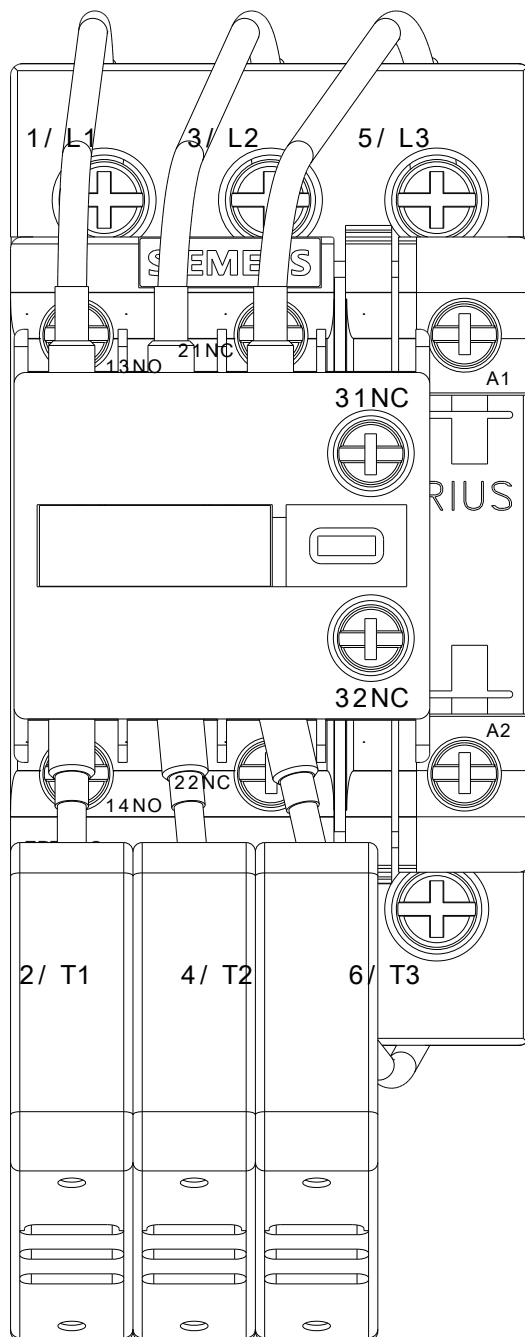

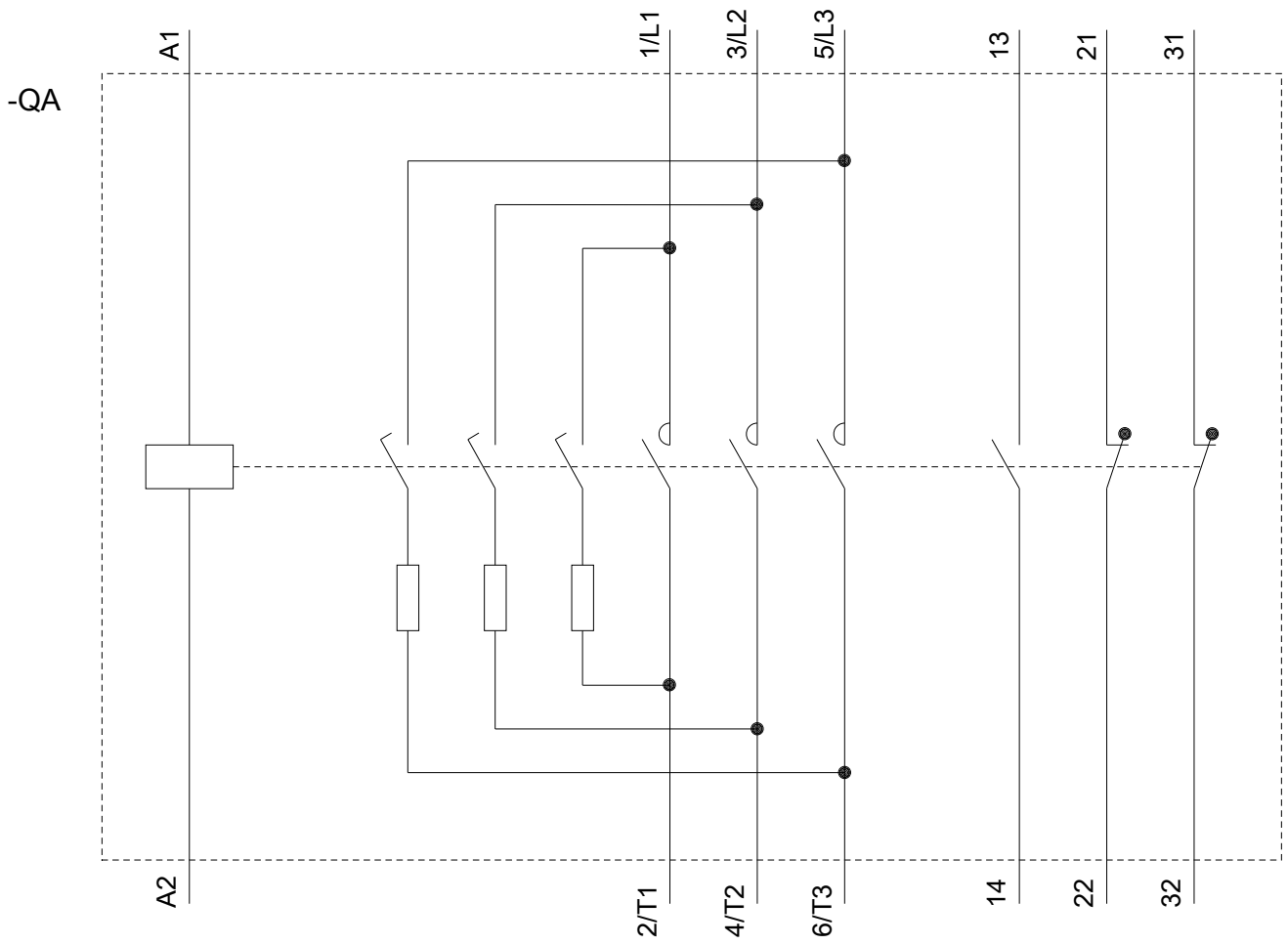

last modified:

08/01/2019